

Aluminum Railing Technologies Ltd.

APPROVAL STAMPS

TEST DRAWINGS

LAB: CAN-BEST LABORATORIES

LOCATION: 38 Regan Road, Unit 4. Brampton, Ontario, Canada, L7A 1C6

TYPES: RAILING TYPE - 4H

NOTES: _____

TEST DRAWING SET DATE: June 04, 2021

66 RIVALDA ROAD, TORONTO, ONTARIO, CANADA M9M 2M3
E-MAIL: falbo@on.aibn.com

Tel: (416) 740 - 2328 , 1(800) 538 - 7030
Fax: (416) 740 - 0720

ITEM NO.	DESCRIPTION	PART NUMBER
1	TOP CAP	AS-36124
2	TOP RAIL	AS-36087
3	TOP GASKET	V-822
4	4+4MM HEAT SOAKED LAMINATED GLASS	
5	POST	AH-72863
9	BOTTOM GASKET	V-823
10	BOTTOM GLASS CHANEL	AS-72864
11	SIDE ASSEMBLED SHOE	
12	SS 1/2"Ø x 4 1/2" EXPANSION ANCHORS	STAINLESS STEEL
14	SS 3/8"Ø x 2 1/2" TRU BOLT	Flat washer, lock washer, nut

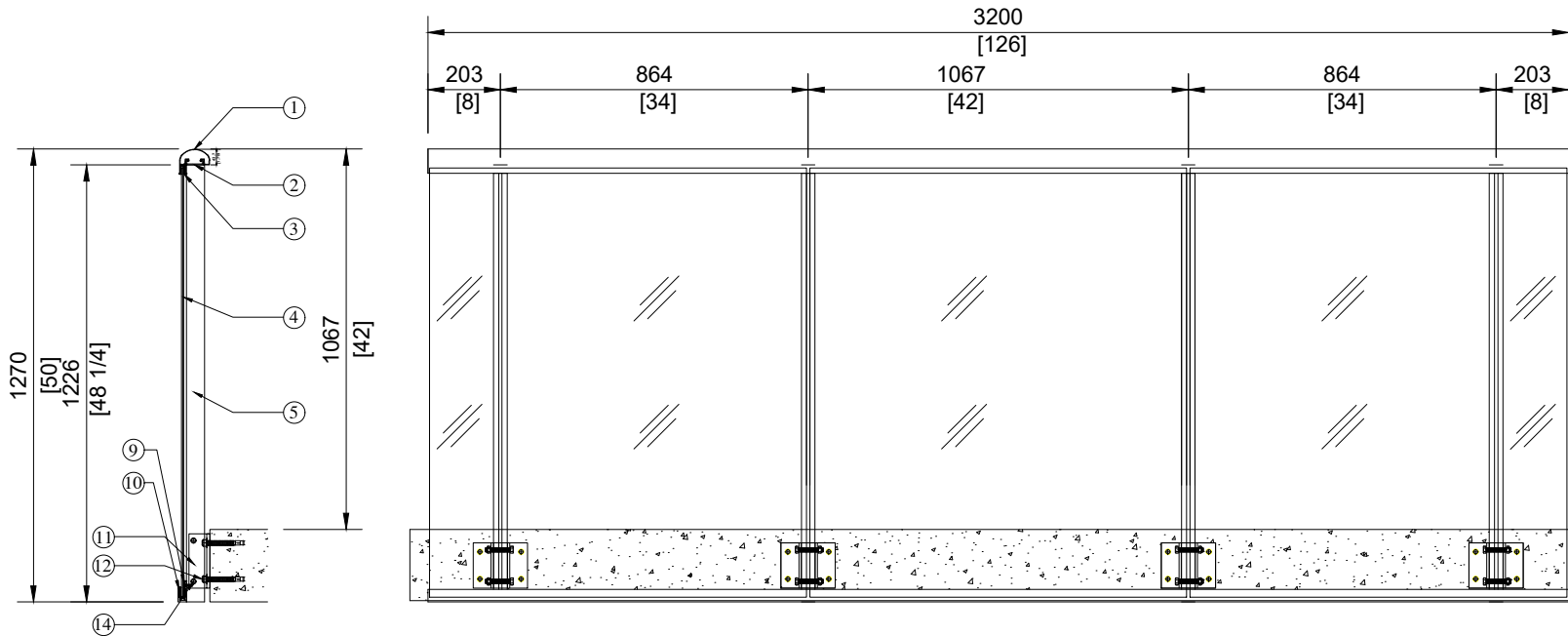

DRAWN BY: SR	DATE: June 04, 2021
CHECKED BY: EF	SCALE: NTS.

PROJECT:
RAILING TEST

DRAWING TITLE:
TYPE 4H
BALCONY RAILING





ART

aluminum railing technologies Ltd.

66 Rivalda Rd, Toronto, Ontario M9M 2M3
Tel: (416) 740-9304 Fax: (416) 740-0720
Email:

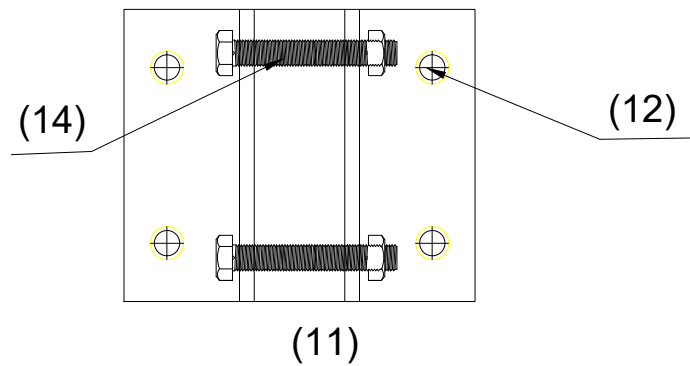
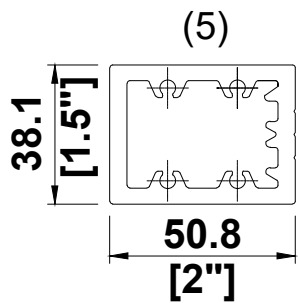
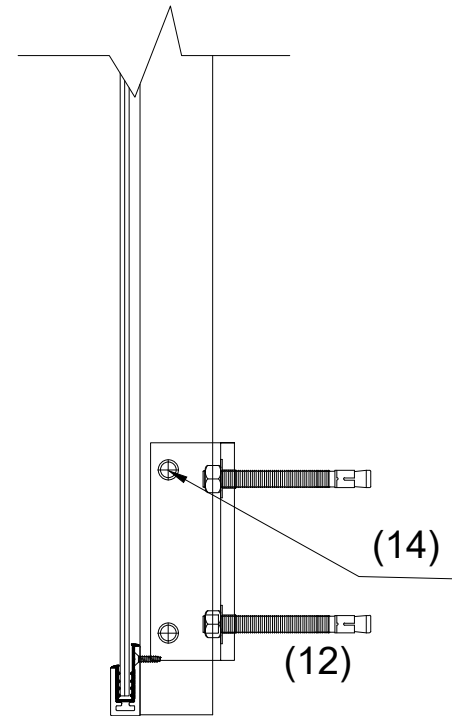
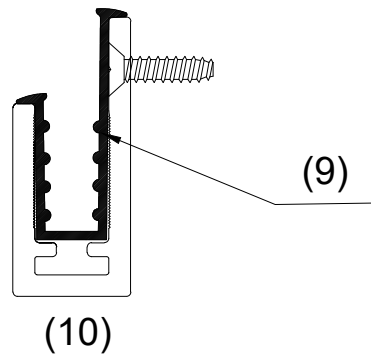
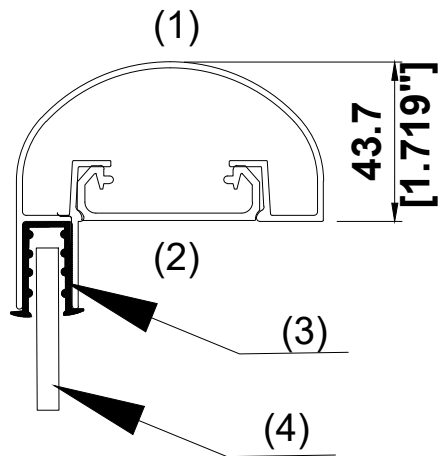
DRAWING NO:
RT-01



DRAWN BY: SR	DATE: June 04, 2021
CHECKED BY: EF	SCALE: NTS.
PROJECT: RAILING TEST	
DRAWING TITLE: TYPE 4H BALCONY RAILING	
 ART aluminum railing technologies Ltd.	
66 Rivalda Rd, Toronto, Ontario M9M 2M3 Tel: (416) 740-9304 Fax: (416) 740-0720 Email:	
DRAWING NO: RT-02	

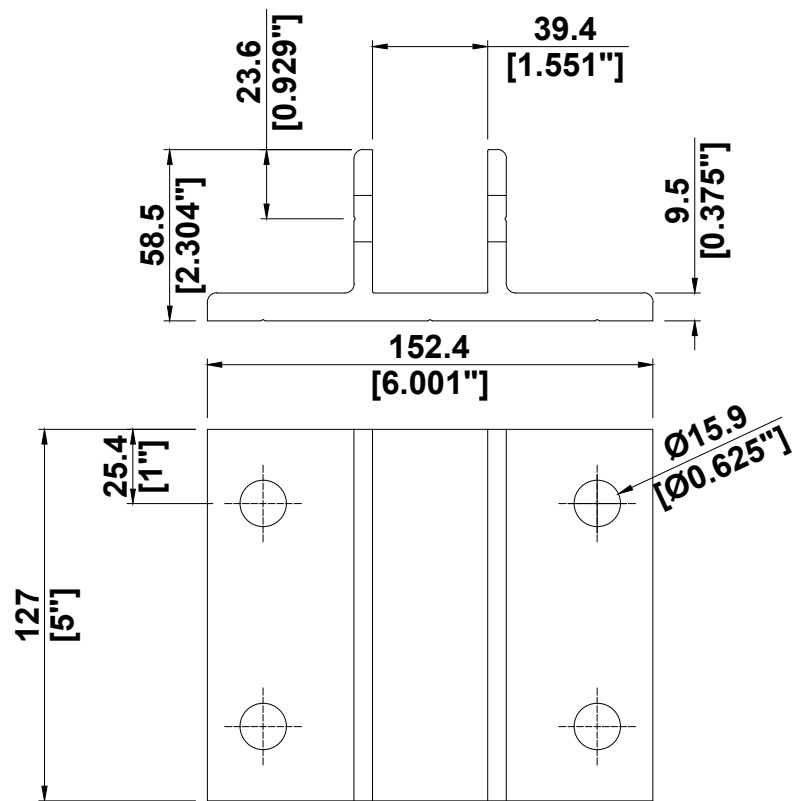

DRAWN BY: SR	DATE: June 04, 2021
-----------------	------------------------

CHECKED BY: EF	SCALE: NTS.
-------------------	----------------

PROJECT: RAILING TEST

DRAWING TITLE: TYPE 4H BALCONY RAILING
--



ART

aluminum railing technologies ltd.

66 Rivalda Rd, Toronto, Ontario M9M 2M3
Tel: (416) 740-9304 Fax: (416) 740-0720
Email :

DRAWING NO: RT-03
